

## Technical Data Sheet

### Full Color Side View LEDs (Height 0.8mm)

#### 99-235/RSGBB7C-A22/2D

#### Features

- White package.
- Optical indicator.
- Colorless clear window.
- Ideal for backlight and light pipe application.
- Inter reflector.
- Wide viewing angle.
- Suitable for vapor-phase reflow, Infrared reflow and wave solder processes.
- Computable with automatic placement equipment.
- Available on tape and reel (12mm Tape)
- Pb-free
- The product itself will remain within RoHS compliant version.
- MSL-3



#### Descriptions

- The 99-235 series is available in soft red, green and blue. Due to the package design, the LED has wide viewing angle and optimized light coupling by inter reflector. This feature makes the ideal for light pipe application. The low current requirement makes this device ideal for portable equipment or any other application where power is at a premium.

#### Applications

- Telecommunication: indicator and backlighting in telephone and fax.
- Flat backlight for LCD's, switches and symbols.
- Light pipe application.
- General use.

#### Device Selection Guide

Chip			Resin Color
Type	Material	Emitted Color	
RS	AlGaInP	Brilliant Red	Water Clear
GB	InGaN	Brilliant Green	
B7	InGaN	Blue	

## Technical Data Sheet

### Full Color Side View LEDs (Height 0.8mm)

**99-235/RSGBB7C-A22/2D**

#### Package Outline Dimensions

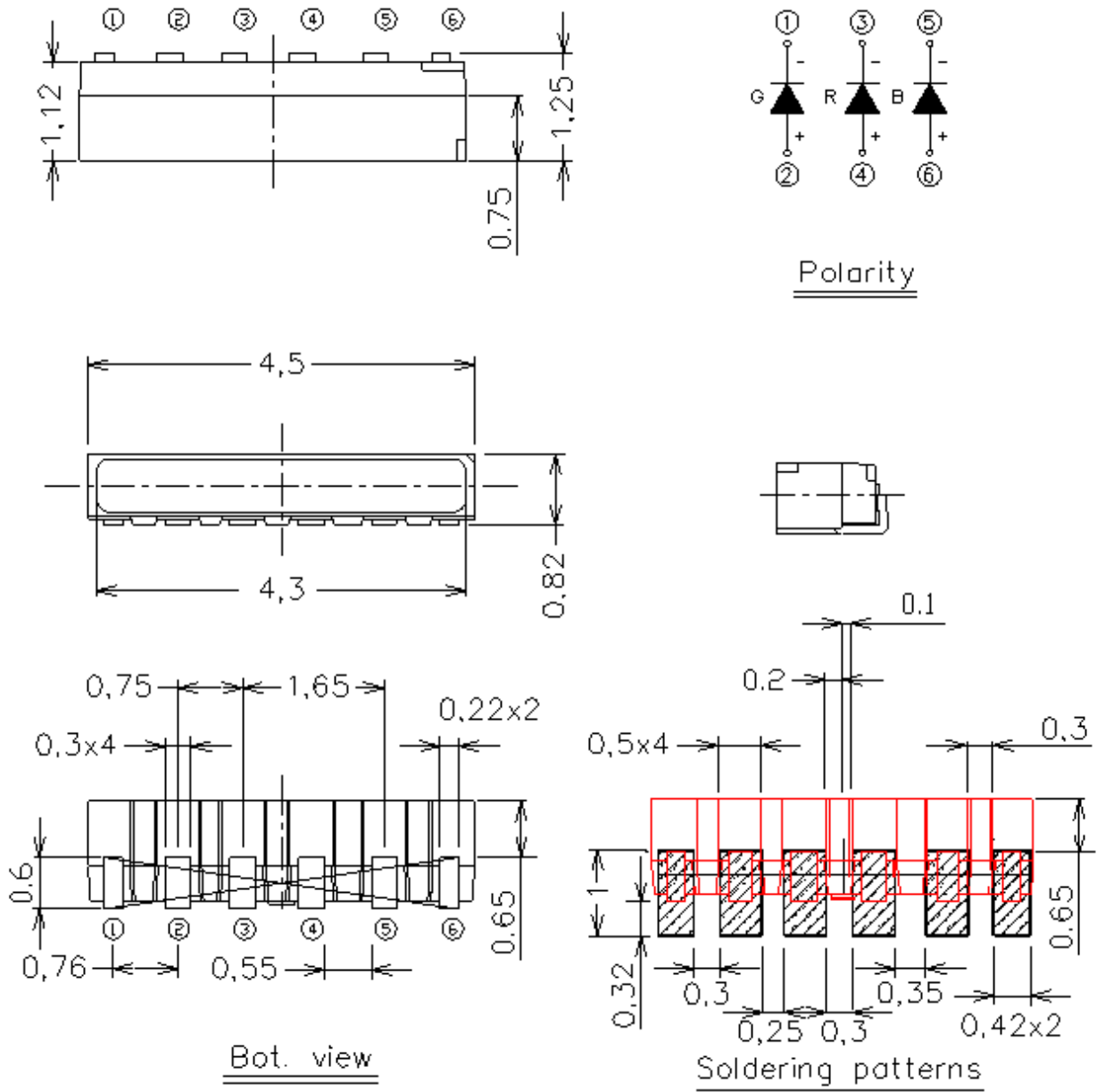

**Note:** The tolerances unless mentioned is  $\pm 0.1\text{mm}$  ;Unit = mm

# Technical Data Sheet

## Full Color Side View LEDs (Height 0.8mm)

### 99-235/RSGBB7C-A22/2D

#### Absolute Maximum Ratings (Ta=25°C)

Parameter	Symbol	Rating	Unit
Reverse Voltage	$V_R$	5	V
Forward Current	$I_F$	RS	50
		GB	30
		B7	30
Peak Forward Current(Duty 1/10@ 1KHZ)	$I_{FP}$	RS	100
		GB	100
		B7	100
Power Dissipation	$P_d$	RS	130
		GB	110
		B7	110
Electrostatic Discharge(HBM)	ESD	RS	2000
		GB	1000
		B7	1000
Operating Temperature	$T_{opr}$	-40 ~ +85	°C
Storage Temperature	$T_{stg}$	-40~ +90	°C
Soldering Temperature	$T_{sol}$	Reflow Soldering : 260 °C for 10 sec. Hand Soldering : 350 °C for 3 sec.	

## Technical Data Sheet

### Full Color Side View LEDs (Height 0.8mm)

#### 99-235/RSGBB7C-A22/2D

#### Electro-Optical Characteristics (Ta=25°C)

Parameter	Symbol	Min.	Typ.	Max.	Unit	Condition
Luminous Intensity	I <sub>v</sub>	RS	225	-----	560	mcd
		GB	715	-----	1420	
		B7	57	-----	140	
Viewing Angle	2θ 1/2		-----	120	-----	deg
Dominant Wavelength	λ <sub>d</sub>	RS	618	-----	627	nm
		GB	520	-----	535	
		B7	457	-----	466	
Forward Voltage	V <sub>F</sub>	RS	1.80	-----	2.30	V
		GB	2.75	-----	3.45	
		B7	2.75	-----	3.45	
White point coordinate	x	-----	-----	0.294	-----	-----
	y	-----	-----	0.286	-----	
Reverse Current	I <sub>R</sub>	RS	-----	-----	10	μA

#### Notes:

1. Tolerance of Luminous Intensity ±11%
2. Tolerance of Dominant Wavelength ±1nm
3. Tolerance of Forward Voltage : ±0.1V

# Technical Data Sheet

## Full Color Side View LEDs (Height 0.8mm)

**99-235/RSGBB7C-A22/2D**

### Bin Range of Luminous Intensity

Symbol		Bin Code	Min.	Max.	Unit	Condition
I <sub>v</sub>	RS	S2	225	285	mcd	I <sub>F</sub> =17mA (R) I <sub>F</sub> =18mA (G) I <sub>F</sub> =9mA (B)
		T1	285	360		
		T2	360	450		
		U1	450	560		
	GB	V1	715	900		
		V2	900	1120		
		W1	1120	1420		
	B7	P2	57	72		
		Q1	72	90		
		Q2	90	112		
		R1	112	140		

### Bin Range of Forward Voltage

Symbol		Bin Code	Min.	Max.	Unit	Condition
V <sub>F</sub>	RS	RV1	1.80	2.05	V	I <sub>F</sub> =17mA (R) I <sub>F</sub> =18mA (G) I <sub>F</sub> =9mA (B)
		RV2	2.05	2.30		
	GB	GV1	2.75	3.10		
		GV2	3.10	3.45		
	B7	BV1	2.75	3.10		
		BV2	3.10	3.45		

**Note:**

1. Tolerance of Luminous Intensity:  $\pm 11\%$
2. Tolerance of Forward Voltage:  $\pm 0.1V$

# Technical Data Sheet

## Full Color Side View LEDs (Height 0.8mm)

### 99-235/RSGBB7C-A22/2D

#### Bin Code of Chromaticity Coordinates

R/G/B=17/18/9mA

Bin Code	CIE_x	CIE_y	Bin Code	CIE_x	CIE_y
S1	0.284	0.276	S2	0.304	0.276
	0.284	0.296		0.304	0.296
	0.304	0.296		0.324	0.296
	0.304	0.276		0.324	0.276
S3	0.304	0.296	S4	0.284	0.296
	0.304	0.316		0.284	0.316
	0.324	0.316		0.304	0.316
	0.324	0.296		0.304	0.296
S5	0.264	0.296	S6	0.264	0.276
	0.264	0.316		0.264	0.296
	0.284	0.316		0.284	0.296
	0.284	0.296		0.284	0.276
S7	0.264	0.256	S8	0.284	0.256
	0.264	0.276		0.284	0.276
	0.284	0.276		0.304	0.276
	0.284	0.256		0.304	0.256
S9	0.304	0.256			
	0.304	0.276			
	0.324	0.276			
	0.324	0.256			

**Note:**

Tolerance of Chromaticity Coordinates:  $\pm 0.01$

## Technical Data Sheet

### Full Color Side View LEDs (Height 0.8mm)

99-235/RSGBB7C-A22/2D

#### The C.I.E. 1931 Chromaticity Diagram

R/G/B=17/18/9mA

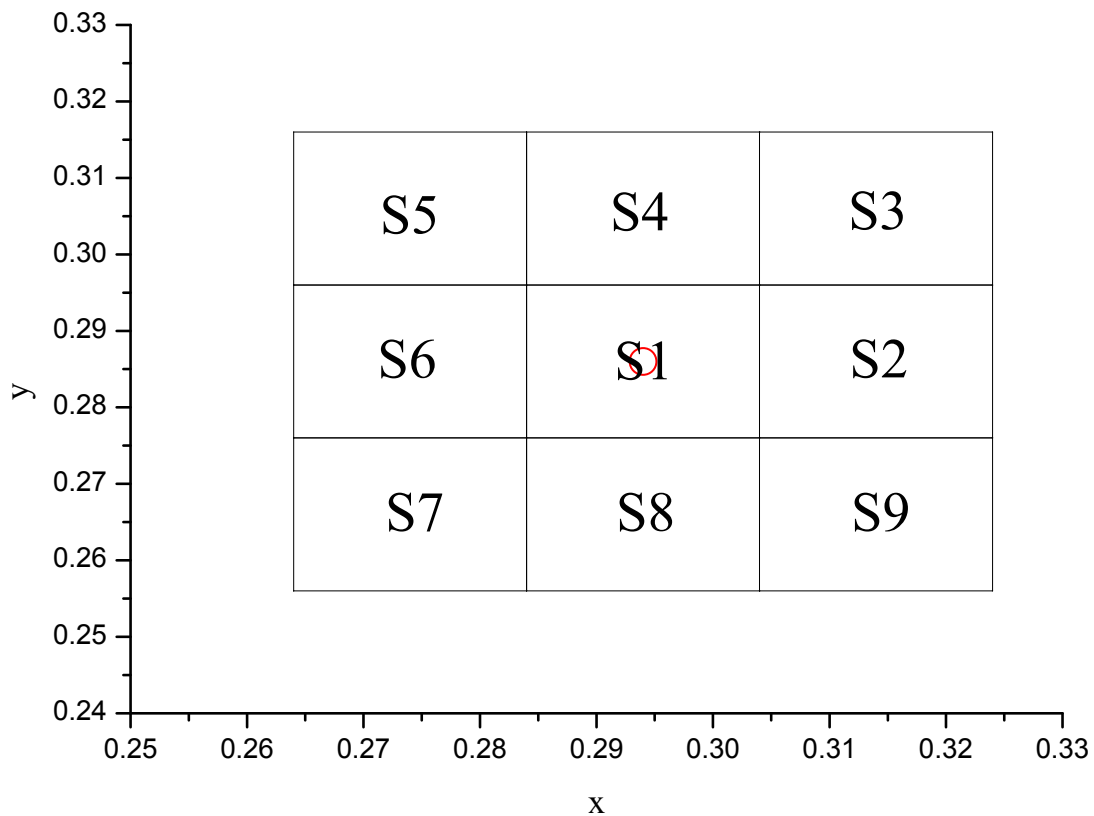

## Technical Data Sheet

### Full Color Side View LEDs (Height 0.8mm)

#### 99-235/RSGBB7C-A22/2D

#### Typical Electro-Optical Characteristics Curves(RS)

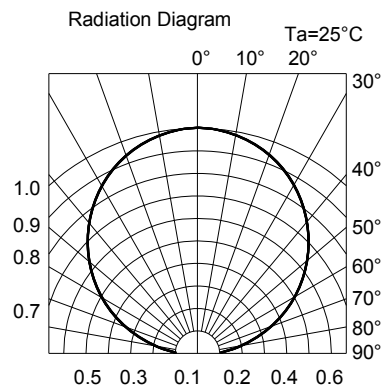
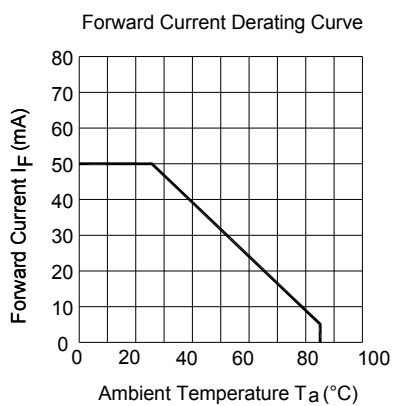
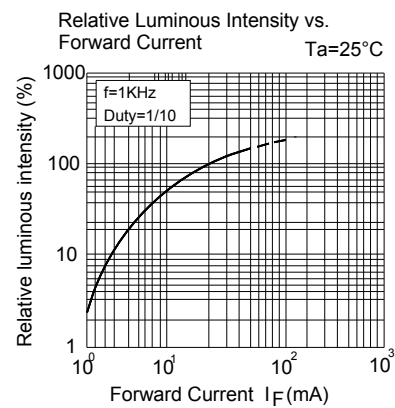
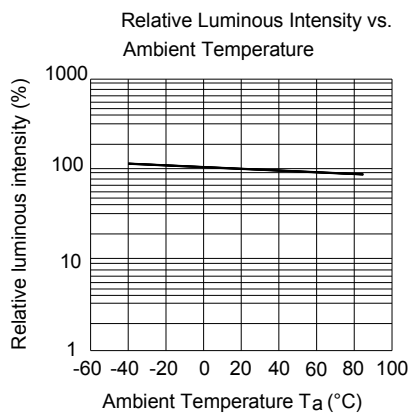
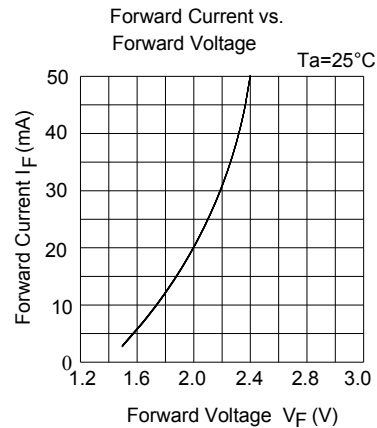
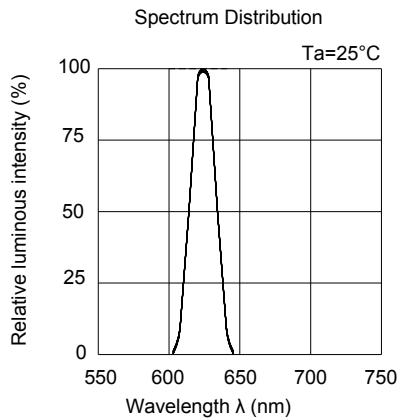



## Technical Data Sheet

### Full Color Side View LEDs (Height 0.8mm)

**99-235/RSGBB7C-A22/2D**

#### Typical Electro-Optical Characteristics Curves(GB)

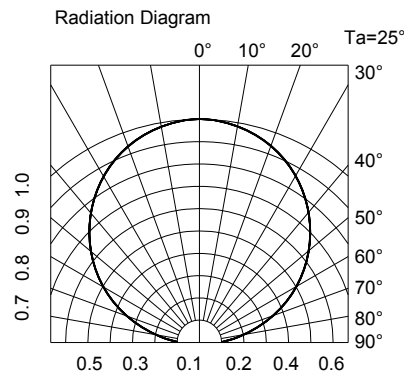
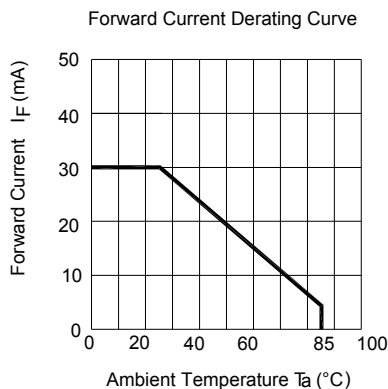
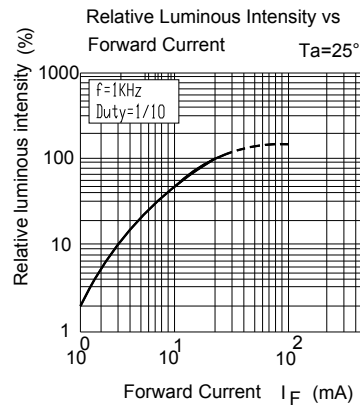
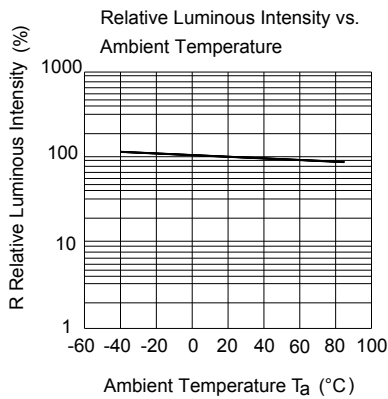
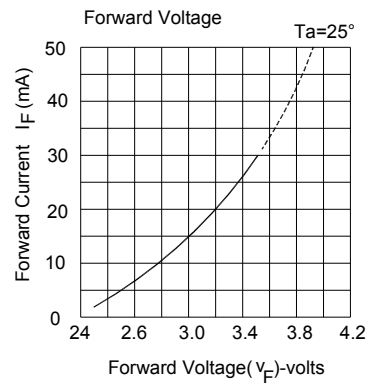
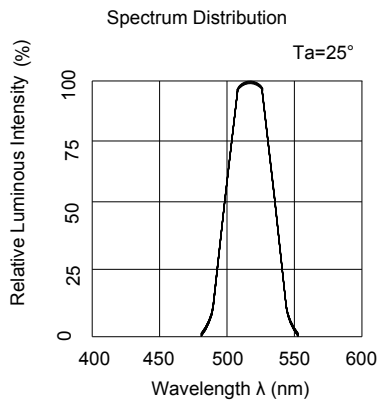

## Technical Data Sheet

### Full Color Side View LEDs (Height 0.8mm)

#### 99-235/RSGBB7C-A22/2D

#### Typical Electro-Optical Characteristics Curves(B7)

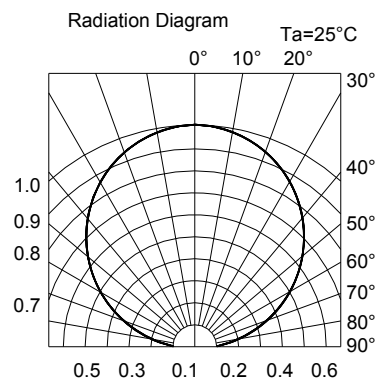
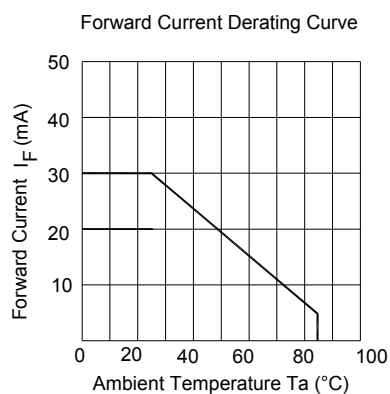
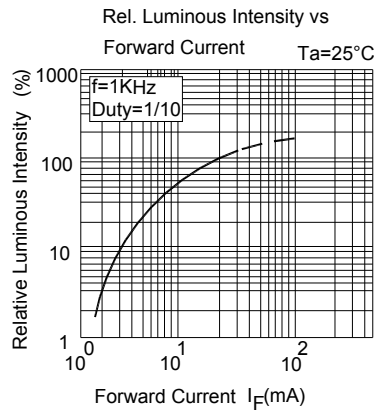
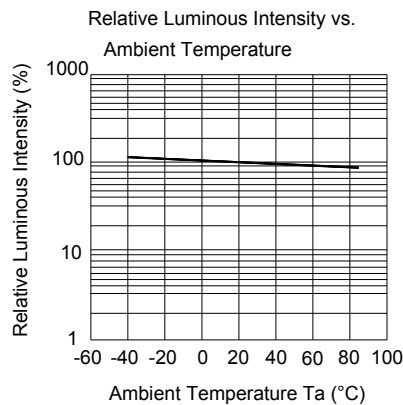
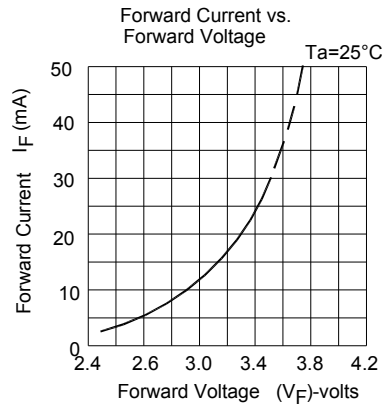
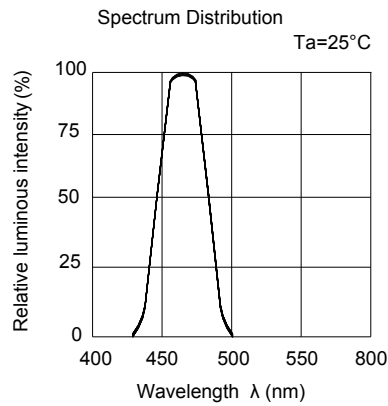

## Technical Data Sheet

### Full Color Side View LEDs (Height 0.8mm)

**99-235/RSGBB7C-A22/2D**

#### Label Explanation

CAT: Luminous Intensity Rank

HUE: Chromaticity Coordinates

REF: Forward Voltage Rank

RoHS	<b>(Pb)</b>	<b>EVERLIGHT</b>	<b>5</b>
CPN: XXXXXXXXXXXXXXXXXXXX			
XXXXXXXXXX-XXXXXXXXXX-XXXXXXXXXX-XXXXXXXXXX-XXXXXX			
P/N: XXXXXXXXXXXX			
XXXXXXXXXX-XXXXXXXXXX-XXXXXXXXXX-XXXXXXXXXX-XXXXXX			
LOT NO: Y150716XXX-XXXXXXXXXX-XXXXXXXXXX			
QTY: 0123456789 HUE: XXXXXXXXXXXX			
CAT: XXXXXXXXXXXX REF: XXXXXXXXXXXX			
REFERENCE: BTPYYMDDXXXXX			
MSL-X MADE IN XXXXXX			



#### Reel Dimensions

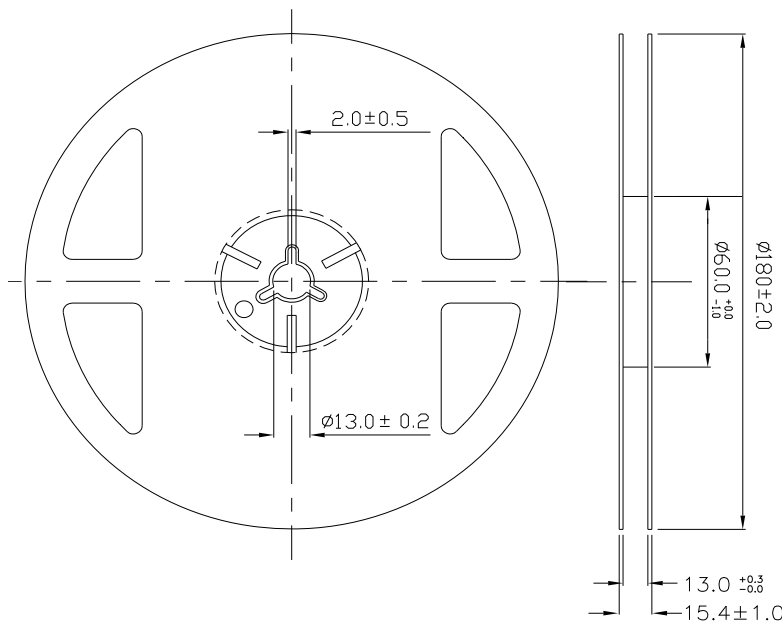

**Note:** The tolerances unless mentioned is  $\pm 0.1$ mm ;Unit = mm

## Technical Data Sheet

### Full Color Side View LEDs (Height 0.8mm)

**99-235/RSGBB7C-A22/2D**

**Carrier Tape Dimensions: Loaded quantity 2000 PCS per reel.**

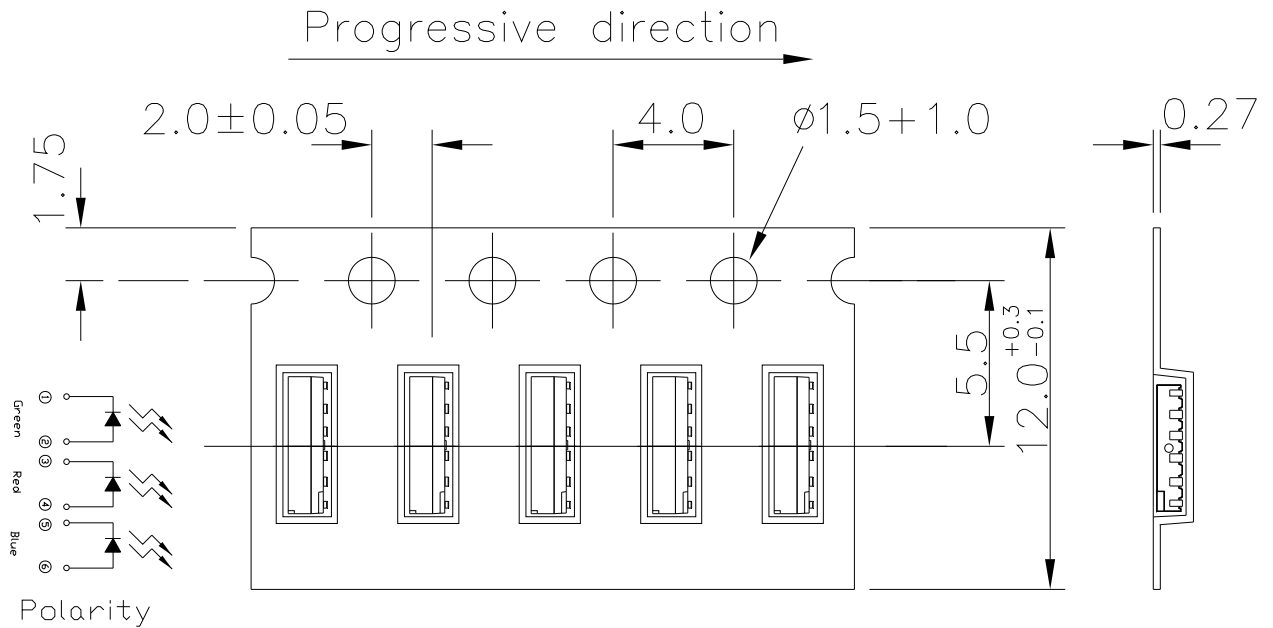

**Note:**

1. Tolerance unless mentioned is  $\pm 0.1$ mm; Unit = mm
2. Minimum packing amount is 250/500/1000/2000 pcs per reel.

### Moisture Resistant Packaging

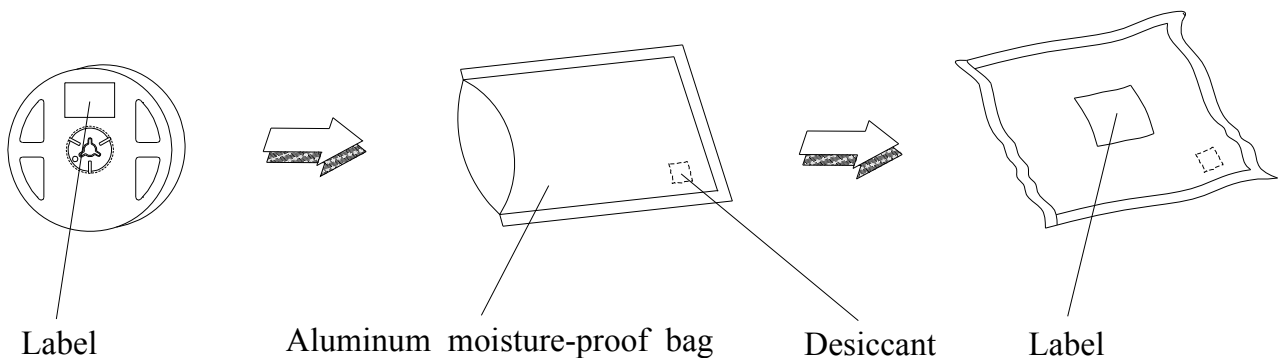

## Technical Data Sheet

### Full Color Side View LEDs (Height 0.8mm)

**99-235/RSGBB7C-A22/2D**

#### Precautions for Use

##### 1. Over-current-proof

Customer must apply resistors for protection, otherwise slight voltage shift will cause big current change ( Burn out will happen ).

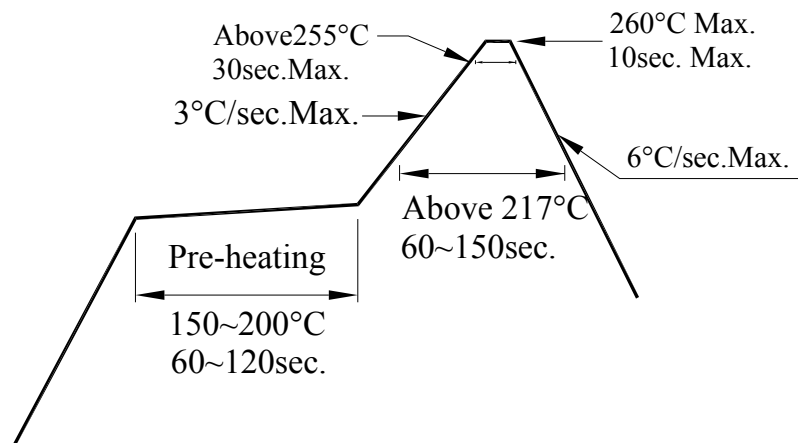

##### 2. Storage

- 2.1 Moisture proof bag should only be opened immediately prior to usage.
- 2.2 Environment should be less than 30°C and 60% RH when moisture proof bag is opened.
- 2.3 After opening the package MSL Conditions stated on page 1 of this spec should not be exceeded.
- 2.4 If the moisture sensitivity card indicates higher than acceptable moisture, the component should be baked at min. 60deg +/-5deg for 24 hours.

##### 3. Soldering Condition

- 3.1 Pb-free solder temperature profile
- 3.2 Reflow soldering should not be done more than two times.
- 3.3 When soldering, do not put stress on the LEDs during heating.
- 3.4 After soldering, do not warp the circuit board.

## Technical Data Sheet

### Full Color Side View LEDs (Height 0.8mm)

---

**99-235/RSGBB7C-A22/2D**

#### 4. Soldering Iron

Each terminal is to go to the tip of soldering iron temperature less than 350°C for 3 seconds within once in less than the soldering iron capacity 25W. Leave two seconds and more intervals, and do soldering of each terminal. Be careful because the damage of the product is often started at the time of the hand solder.

#### 5. Repairing

Repair should not be done after the LEDs have been soldered. When repairing is unavoidable, a double-head soldering iron should be used (as below figure). It should be confirmed beforehand whether the characteristics of the LEDs will or will not be damaged by repairing.

### Application Restrictions

High reliability applications such as military/aerospace, automotive safety/security systems, and medical equipment may require different product. If you have any concerns, please contact Everlight before using this product in your application. This specification guarantees the quality and performance of the product as an individual component. Do not use this product beyond the specification described in this document.

### Revision History:

Rev.	Modified date	File modified contents
1	2010/04/06	New Spec
2	2012/04/16	Approved
3	2013/10/01	Change the QR Code
4	2016/03/24	Modify the storage conditions
5	2016/05/16	Modify the Package Outline Dimensions
6	2016/06/13	Modify green wavelength range and red brightness